

Eagle Quantum® Premier 8 Channel Discrete Input/Output Module (DCIO) EQ3700DCIO

DESCRIPTION

The 8 Channel DCIO Module is specially designed to expand the Input and Output capability of the Det-Tronics Eagle Quantum Premier® (EQP) System.

The unit is designed to provide continuous and automated fire/gas protection, while ensuring system operation through continuous supervision of System Inputs/Outputs and Local Operating Network/Signalling Line Circuit (LON/SLC) monitoring in the controller.

The DCIO module provides eight channels of configurable input or output points that can be programmed for supervised or unsupervised operation. Each input point can accept fire detection devices such as heat, smoke, or unitized flame detectors. Each output point can be configured for signaling or releasing output operation. Each channel on the module is provided with individual indicators for active and fault conditions.

NOTE

An input must be active for at least 750 milliseconds in order to be recognized.

The DCIO module can be mounted directly to a panel, or it can be DIN rail mounted. System status can be determined using the troubleshooting procedures, Eagle Quantum Safety System Software (S³) and the status indicators on the module.



THEORY OF OPERATION

Each channel on the DCIO module can be configured as an input to accept a connection from manual alarm stations, heat sensors, smoke sensors, pressure sensors, or as an output for notification or releasing.

Both input and output circuits can be configured as either a supervised or an unsupervised point. Each input point is also assigned a circuit type, such as: Alarm, Trouble, Supervisory, Gas High, or Low Alarm, or other. The DCIO module reports to the EQP Controller and activates the appropriate static or user logic in the EQP Controller.

The DCIO module supports ANSI/NFPA Class X communications with the Eagle Quantum Premier Controller.

To ensure reliable system operation, the module continuously monitors its input and output circuits for open and short circuit conditions. The Eagle Quantum Premier Controller also continuously monitors the status of the DCIO module as well as the status of each device connected to the DCIO module.

LED INDICATORS

LEDs on the front panel of the DCIO are provided for indicating device status conditions. The LEDs are tested upon power up to verify their operation. Red LEDs indicate an active condition. Yellow LEDs indicate trouble.

MOUNTING

The DCIO module is DIN rail or direct panel mountable for configurations requiring installation in NEMA or IP enclosures. DIN rail and mounting clip options must be specified at the time of order. Refer to the “Specifications” section of this manual for mounting arrangements and dimensions.

FEATURES

- Expands the capabilities of the Det-Tronics Eagle Quantum Premier system
- Monitors eight independent I/O channels
- Individual channels are configurable as an Input or Output
- Individual channels are configurable as supervised or unsupervised points
- Individual point Type is configurable for alarm/supervisory/other input styles, notification/releasing output
- Individual channel LEDs indicate Active and Fault status
- Provides remote I/O capabilities via LON/SLC
- Panel or DIN rail mounting
- Power LED display
- Plug-in wiring connectors
- Meets the requirements of NFPA 72
- RFI and EMI hardened (CE Marked)

SPECIFICATIONS

POWER REQUIREMENTS—

3 watts nominal, 7 watts maximum.

INPUT VOLTAGE—

24 Vdc nominal, 18 to 30 Vdc. 10% overvoltage will not cause damage to the equipment.

SLC OUTPUT—

Digital communication, transformer isolated (78.5 kbps).

TEMPERATURE RANGE—

Operating: -40°F to $+185^{\circ}\text{F}$ (-40°C to $+85^{\circ}\text{C}$).
Storage: -67°F to $+185^{\circ}\text{F}$ (-55°C to $+85^{\circ}\text{C}$).

HUMIDITY RANGE—

0 to 95% RH, non-condensing.

VIBRATION—

FM 3260-2000 (clause 4.9).

DIMENSIONS—

Refer to Figure 1.

SHIPPING WEIGHT—

1 pound (0.45 kilograms).

CERTIFICATION—

FM / CSA: Class I, Div. 2, Groups A, B, C, D (T4).
Class I, Zone 2, Group IIC (T4).

CE: ATEX/EMC Directive Compliant.

ATEX: Ex II 3 G
Ex nA nC IIC T4 Gc
DEMKO 02 ATEX 133864X
Tamb = -40°C to $+85^{\circ}\text{C}$.

IECEX: IECEx ULD 10.0004X
Ex nA nC IIC T4 Gc
Tamb = -40°C to $+85^{\circ}\text{C}$.

Special conditions for safe use:

The device shall be installed in an enclosure that complies with all relevant requirements of EN 60079-15:2010, and provides a degree of ingress protection of at least IP54. The device may only be installed, connected, or removed when the area is known to be non-hazardous.



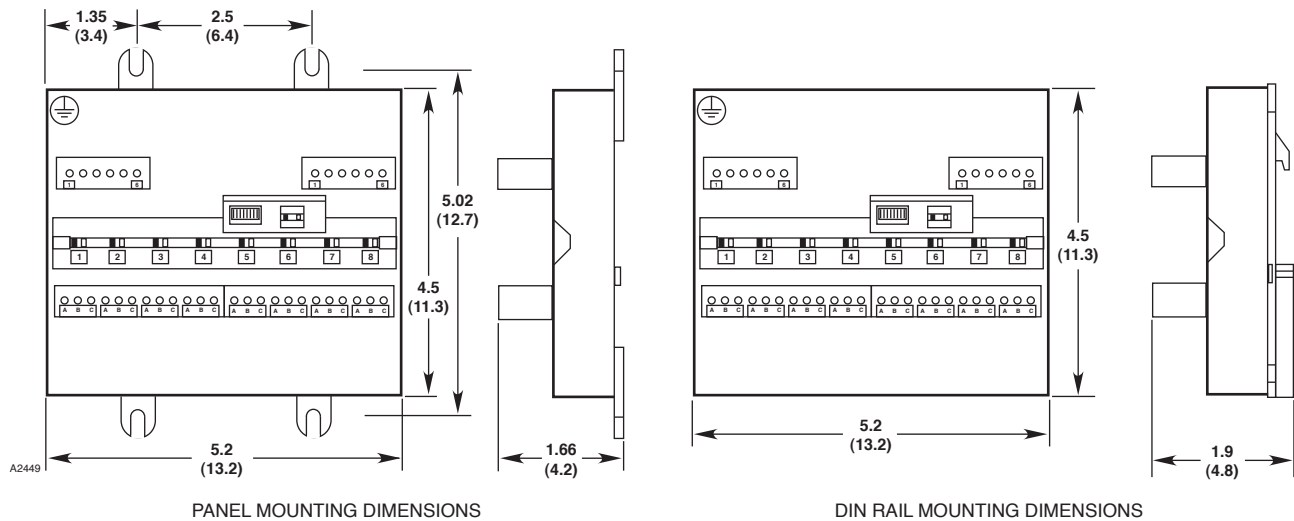

Figure 1—Dimensions of the DCIO Module in Inches (Centimeters)

INPUT / INITIATING DEVICE CIRCUITS

UNSUPERVISED INPUT—

Two state input (on/off)
Normally open contact

SUPERVISED INPUT, CLASS B OPEN CIRCUIT—

Two state input (active/trouble):

- End of Line Resistor 10 K ohms nominal
- Open Circuit > 45 K ohms
- Active Circuit < 5 K ohms

SUPERVISED INPUT, CLASS B OPEN AND SHORT CIRCUIT—

Three state input (active/short/open):

- End of Line Resistor 10 K ohms nominal
- In Line Resistor 3.3 K ohms nominal
- Open Circuit > 45 K ohms
- Short Circuit < 1.4 K ohms
- Active Circuit 2.5 K ohms to 5 K ohms

INPUT, TYPES—

Configurable for static logic applications:

- Fire Alarm
- Supervisory
- Trouble
- High Gas Alarm
- Low Gas Alarm
- Other

OUTPUT / NOTIFICATION / RELEASING OR UNSUPERVISED DEVICE CIRCUITS

UNSUPERVISED OUTPUT RATING—

Rating: 2 amps at 30 Vdc maximum.
Note: Voltage available at outputs is dependent on input voltage ($V_{out} \approx V_{in} - 1 \text{ Vdc}$).

OUTPUT STYLE—

Form "A" normally off.

RESPONSE TIME—

Output actuates in <0.15 second after acknowledging an alarm command message.

SUPERVISED OUTPUT RATING—SIGNALING CIRCUIT, CLASS B WIRING

MAXIMUM OUTPUT CURRENT—

2 amps at 30 Vdc maximum, 15 amp inrush.
Automatic short circuit protection provided.

SUPERVISORY CURRENT—

Reverse current monitored at $1.5 \text{ mA} \pm 0.5 \text{ mA}$.

RESPONSE TIME—

Output actuates in <0.15 second after acknowledging an alarm command message.

EOL RESISTORS—

10 K ohms $\pm 2 \text{ K ohms}$. Each circuit must have an EOL resistor.

SIGNALING OUTPUT, TYPES—

Configurable for device applications:

- Continuous
- 60 beats per minute
- 120 beats per minute
- Temporal Pattern
- Supervisory Tone
- Trouble Tone

Note: All eight channels are synchronized when programmed as a signaling output.

SUPERVISED OUTPUT RATING— Releasing Circuit, Class B

MAXIMUM OUTPUT CURRENT—

2 amps at 30 Vdc maximum, 15 amp inrush.
Automatic short circuit protection provided.

SUPERVISORY CURRENT—

Monitored at 1.3 mA \pm 0.2 mA.

RESPONSE TIME—

Output actuates in <0.15 second after acknowledging an alarm command message.

RELEASING OUTPUT, TYPES—

Configurable for device applications:

- Continuous
- Timed

INSTALLATION

All electrical connections are made to the field wiring connectors furnished with the module. Refer to Figure 2 for identification of module wiring terminals.

Connector P1, Terminals 1 to 6 24 Vdc Power Input

Connect the module power supply to terminals 1 and 2. If additional terminals are required for powering other devices, these devices should be connected to terminals 4 and 5. Shields are to be connected to terminals 3 and 6 — chassis (earth) ground terminals. Terminals are rated for 10 amps. Use both sets of input terminals in parallel if total output current can exceed 10 amps.

Connector P2, Terminals 1 to 6 LON/SLC Signaling Circuit Terminals

Be sure to observe polarity when wiring the LON/SLC. shield connection — terminals 3 and 6.

- 1 — "A" side of signaling circuit for COM 1
- 2 — "B" side of signaling circuit for COM 1
- 4 — "A" side of signaling circuit for COM 2
- 5 — "B" side of signaling circuit for COM 2

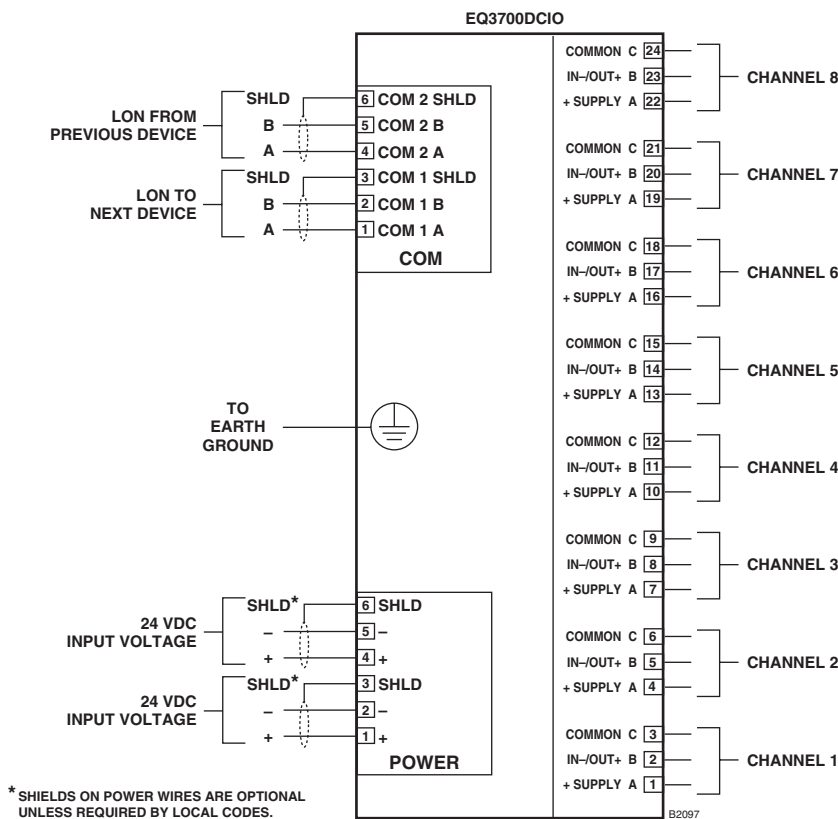

Figure 2—DCIO Module Wiring Terminal Configuration

Connector P3, Terminals 1 to 12
Terminals A,B & C
Channels 1 to 4 Input / Output Terminals

Refer to individual wiring configurations for terminal descriptions. Only channel 1 is shown in each diagram. The information is typical for channels 2–8.

Connector P4, Terminals 13 to 24
Terminals A, B & C
Channels 5 to 8 Input / Output Terminals

Refer to individual wiring configurations for terminal descriptions. Only channel 1 is shown in each diagram. The information is typical for channels 2–8.

Unsupervised Input

Connect external system wiring to the appropriate terminals on the terminal block. See Figure 3.

The input to the DCIO consists of one or more normally open or normally closed switches. An EOL resistor is not required.

No connection should be made to “+ Supply” terminal.

Supervised Input (IDC) Open Circuit Supervision

Connect external system wiring to the appropriate terminals on the terminal block. See Figure 4.

The input to the DCIO module consists of one or more normally open switches, with a 10 K ohm, 1/4 watt EOL resistor in parallel across the last switch.

No connection should be made to “+ Supply” terminal.

Supervised Input (IDCSC) Open and Short Circuit Supervision

Connect external system wiring to the appropriate terminals on the terminal block. See Figure 5.

The input to the DCIO module consists of one or more normally open switches, with a 10 K ohm, 1/4 watt EOL resistor in parallel across the last switch and a 3.3 K ohm, 1/4 watt in-line resistor with each switch in the circuit.

No connection should be made to “+ Supply” terminal.

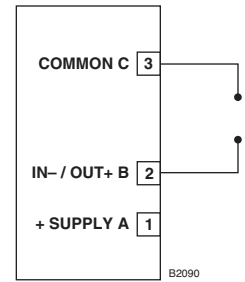

Figure 3—Unsupervised Input Configuration

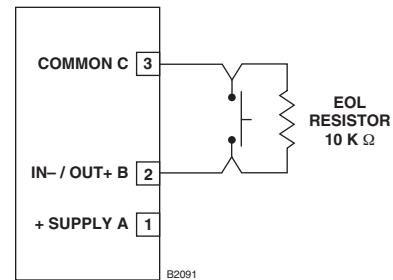

Figure 4—Supervised Input Configuration

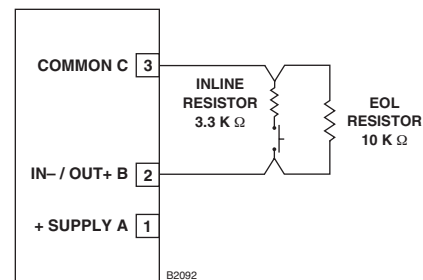

Figure 5—Supervised Input Configuration (Opens and Shorts)

Input — Deluge and Pre-Action

The initiating device circuit(s) for use with the deluge and pre-action system configuration must be wired within 20 feet (6.1 m) and in conduit from the DCIO. See Table 2 for a list of FM Approved solenoids for deluge and pre-action applications.

Unsupervised Output

Connect external system wiring to the appropriate terminals on the terminal block. See Figure 6.

No connection should be made to “+ Supply” terminal.

Supervised Output

Notification Supervised for Open & Short Circuits

Connect external system wiring to the appropriate terminals on the terminal block. See Figure 7.

The output of the DCIO module supervises the notification circuit by reversing the polarity of the monitoring circuit. Polarity must be observed when connecting the notification device. It is essential to utilize a notification device approved for fire alarm notification. These devices are polarized and would not require the use of an external diode for the supervision of the circuit. Wire one or more notification devices to the output, with a 10 K ohm, 1/4 watt EOL resistor in parallel across the last device.

No connection should be made to “+ Supply” terminal.

Each output channel is individually activated for response pattern:

- Supervisory
- Continuous output
- 60 beats per minute
- 120 beats per minute
- Temporal
- Timed
- Trouble

Supervised Output

Agent Release

Connect external system wiring to the appropriate terminals on the terminal block. See Figure 8.

Wire one or more releasing devices to the module output.

No connection should be made to “+ Supply” terminal.

The output of the DCIO module supervises the releasing circuit via the coil of the releasing solenoid. It is essential to utilize a releasing device approved for use with this output module. This type of output does not require the use of EOL resistors or diodes to supervise the circuit.

The output can be configured for latching, continuous, supervisory, trouble, or timed response.

To ensure adequate operating voltage for the output device, the maximum wiring length from the power source to the output device must not exceed the

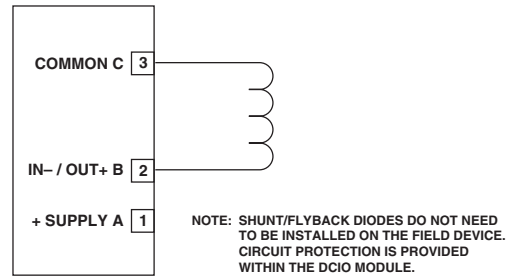

Figure 6—Unsupervised Output Configuration

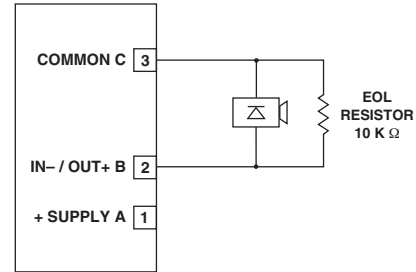

Figure 7—Supervised Output Configuration (Notification)

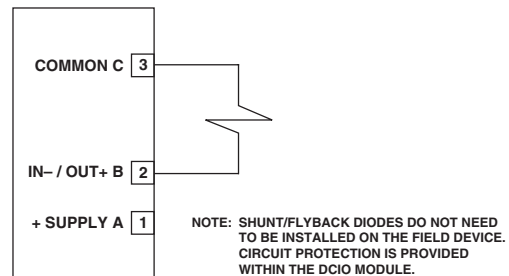

Figure 8—Supervised Output Configuration (Agent Release)

values shown in Table 1 for automatic release applications or Table 2 for deluge and pre-action applications. (For solenoids, this wire length includes both the wiring from the power supply to the DCIO module and the wiring from the module to the solenoid.)

NOTE

Squibs are not compatible with this output. If squib actuation is required, use EQ2500ARM release module.

Supervised Output for Deluge and Pre-action

To ensure proper operating voltage, the input voltage to the DCIO must be in the range from 21–30 Vdc and the maximum wiring length must not exceed the values shown in Table 2 for deluge and pre-action applications. Per FM Approval requirements, the secondary power must provide capacity for a 90 hour minimum standby operation followed by a minimum of 10 minutes of releasing and alarm operation. **The initiating device circuit(s) for use with the deluge and pre-action system configuration must be wired in conduit within 20 feet from the DCIO.**

Table 1—Maximum Wire Length for Releasing Applications

Device	Maximum Wire Length in Feet			
	12 AWG	14 AWG	16 AWG	18 AWG
890181*	150	100	60	
899175*	150	100	60	
895630-000*	150	100	60	
897494*	190	120	75	
486500-001*	1500	1000	600	400
31-199932-004*	150	100	60	
2 Amp Load	190	120	75	

*Fenwal Solenoid

Table 2—Maximum Wire Length for FM Approved Solenoids for Deluge and Pre-Action Applications

Solenoids			Maximum Wire Length in Feet (Meters)			
FM Solenoid Group	Manufacturer	Model	12 AWG	14 AWG	16 AWG	18 AWG
B	ASCO	T8210A107	183 (56)	115 (35)	72 (22)	46 (14)
D	ASCO	8210G207	314 (96)	198 (60)	124 (38)	78 (24)
E	Skinner	73218BN4UNLVNOC111C2	331 (101)	208 (63)	131 (40)	82 (25)
F	Skinner	73212BN4TNLVNOC322C2	130 (40)	82 (25)	51 (16)	32 (10)
G	Skinner	71395SN2ENJ1NOH111C2	331 (101)	208 (63)	131 (40)	82 (25)
H	Viking	HV-274-0601	180 (55)	110 (34)	70 (21)	45(14)

ORDERING INFORMATION

When ordering, please specify:

EQ3700DCIO 8 Channel Discrete Input/Output
Module

Options Panel Mount
 DIN Rail Mount
 EOL Resistors



90-1149

Specifications subject to change without notice.

All trademarks are the property of their respective owners.
© 2016 Detector Electronics Corporation. All rights reserved.



Corporate Office

6901 West 110th Street | Minneapolis, MN 55438 USA

Main: 952.941.5665 or 800.468.3244

Customer Service: 952.946.6491 or 800.765.3473

www.det-tronics.com | Email: det-tronics@det-tronics.com